



ATI Radeon HD 3400 Series

User Guide

Part Number: 137-41448

© 2007 Advanced Micro Devices Inc. All rights reserved.

The contents of this document are provided in connection with Advanced Micro Devices, Inc. ("AMD") products. AMD makes no representations or warranties with respect to the accuracy or completeness of the contents of this publication and reserves the right to make changes to specifications and product descriptions at any time without notice. The information contained herein may be of a preliminary or advance nature and is subject to change without notice. No license, whether express, implied, arising by estoppel or otherwise, to any intellectual property rights is granted by this publication. Except as set forth in AMD's Standard Terms and Conditions of Sale, AMD assumes no liability whatsoever, and disclaims any express or implied warranty, relating to its products including, but not limited to, the implied warranty of merchantability, fitness for a particular purpose, or infringement of any intellectual property right. AMD's products are not designed, intended, authorized or warranted for use as components in systems intended for surgical implant into the body, or in other applications intended to support or sustain life, or in any other application in which the failure of AMD's product could create a situation where personal injury, death, or severe property or environmental damage may occur. AMD reserves the right to discontinue or make changes to its products at any time without notice.

AMD's products are not designed, intended, authorized or warranted for use as components in systems intended for surgical implant into the body, or in other applications intended to support or sustain life, or in any other application in which the failure of AMD's product could create a situation where personal injury, death, or severe property or environmental damage may occur. AMD reserves the right to discontinue or make changes to its products at any time without notice.

Trademarks

AMD, the AMD Arrow logo, AMD Athlon, AMD Opteron and combinations thereof, ATI and ATI product and product-feature names are trademarks of Advanced Micro Devices, Inc.

HyperTransport is a licensed trademark of the HyperTransport Technology Consortium.

Microsoft is a registered trademark of Microsoft Corporation.

Other product names used in this publication are for identification purposes only and may be trademarks of their respective companies.

Disclaimer

While every precaution has been taken in the preparation of this document, Advanced Micro Devices, Inc. assumes no liability with respect to the operation or use of AMD hardware, software or other products and documentation described herein, for any act or omission of AMD concerning such products or this documentation, for any interruption of service, loss or interruption of business, loss of anticipatory profits, or for punitive, incidental or consequential damages in connection with the furnishing, performance, or use of the AMD hardware, software, or other products and documentation provided herein.

Advanced Micro Devices, Inc. reserves the right to make changes without further notice to a product or system described herein to improve reliability, function or design. With respect to AMD products which this document relates, AMD disclaims all express or implied warranties regarding such products, including but not limited to, the implied warranties of merchantability, fitness for a particular purpose, and non-infringement.

Product Notices

Dolby® Laboratories, Inc.

Manufactured under license from Dolby® Laboratories. Dolby and the double-D symbol are trademarks of Dolby Laboratories. Confidential Unpublished Works.

© 1992-1997 Dolby Laboratories, Inc. All rights reserved.

Macrovision

Apparatus Claims of U.S. Patent Nos. 4,631,603; 4,819,098; 4,907,093; 5,315,448; and 6,516,132. Licensed for limited viewing uses only.

This product incorporates copyright protection technology that is protected by US patents and other intellectual property rights. Use of this copyright protection technology must be authorized by Macrovision, and is intended for home and other limited viewing uses only unless otherwise authorized by Macrovision. Reverse engineering or disassembly is prohibited.

Documentation Updates

AMD is constantly improving its product and associated documentation. To maximize the value of your AMD product, you should ensure that you have the latest documentation. AMD's documentation contains helpful installation/configuration tips and other valuable feature information.

Important Safety Instructions

Note: This product is for use only with compatible UL listed personal computers that have installation instructions detailing user installation of this class of product.

1. Read all the instructions.
Read all the safety and operating instructions before the product is operated.
2. Retain the instructions.
Retain the safety and operating instructions for future reference.
3. Heed all warnings.
Obey all warnings on the product and in the instructions.
4. Ground appropriately.

Caution:

For continued protection against the risk of electric shock and fire, install this accessory only in products equipped with a three-wire grounding plug, a plug having a third (grounding) pin. A 3-pin plug will only fit into a grounding-type power outlet. This is a safety feature. If you are unable to insert the plug into the desired outlet, contact an electrician to replace the obsolete outlet. Do not remove the grounding pin of a three-pin plug.

5. Attach card securely.
Completely tighten all product-securing pins to provide continuous bonding between the product and the computer chassis.
6. For cards with TV tuners:
 - a. Ground outdoor antenna appropriately.

Caution:

Since an outdoor antenna or cable system may be connected to the product, be sure that the antenna or cable system is grounded so as to provide some protection against voltage surges and built-up static charges. Article 810 of the *National Electrical Code, ANSI/NFPA 70*, provides information with regard to proper grounding of the mast and supporting structure, grounding of the lead-in wire to the antenna discharge unit, size of grounding conductors, location of antenna-discharge unit, connection of grounding electrodes, and requirements for the grounding electrode.

- b. Unplug during storms and when unused for long periods of time.

Caution:

For added protection for this product during a lightning storm, or when it is left unattended and unused for long periods of time, unplug it from the wall outlet and disconnect the antenna or cable system. This will prevent damage to the product from power-line surges.

- c. Install outdoor antenna system away from power lines.

Warning:

When installing an outside antenna system, extreme care should be taken to keep from touching such power lines or circuits, as contact with them may be fatal.

Caution:

An outside antenna system should not be located in the vicinity of overhead power lines or other light or power circuits, or where it can fall into such power lines or circuits.

Note to CATV system installer:

This reminder is provided to call the CATV systems installer's attention to Section 820-40 of the NEC, which provides guidelines for proper grounding and, in particular, specifies that the cable ground shall be connected to the grounding system of the building as close to the point of cable entry as is practical.

Contents

Installation	1
Installation Overview	1
Replacing an Existing Card	1
First Card for this PC	1
Record the Serial and Part Numbers	1
Uninstalling the Old Driver (Windows® XP)	2
Uninstalling the Old Driver (Windows Vista™)	2
Installing the Graphics Card	3
Installing the ATI Catalyst™ Software Suite	4
Display Configuration	5
Configure the Display (Optional)	5
ATI Radeon HD 3400 series Connections	6
Display Adapters (Optional Accessories)	6
Supported Display Connections	7
ATI CrossFireX	9
ATI CrossFireX Introduction	9
Installing a Graphics Cards for Hybrid ATI CrossFireX Setup	9
Installing the Second Card for ATI CrossFireX Setup	11
Enabling ATI CrossFireX	13
ATI CrossFireX Troubleshooting	13
Change Motherboard BIOS Settings	13
Use Graphics Cards with Different Amounts of Memory	13
3D Client is Active	14
ATI CrossFireX is Currently Unavailable	14
Screen Rotation is Unavailable	14
Video Displays Flicker During System Startup	14
ATI CrossFireX Starts in Software Mode	14
ATI CrossFireX Disabled After Swapping/Moving Cards	14
Reference	15
System Requirements	15
Hardware	15
CrossFire Requirements	15
Using ATI Catalyst Control Center	15
ATI Catalyst Control Center Overview	15
Starting the ATI Catalyst Control Center Software	16
Accessing ATI Catalyst Control Center Help	16
Searching the Help	17
Graphics Card Installation Troubleshooting Tips	17

The graphics card doesn't fit any of the motherboard slots.	17
The computer beeps and the boot process stops.	17
The computer does not boot up properly.	17
The computer boots up but there is no display.	17
HDTV/HDTV Adapter Troubleshooting	17
Customer Care	18
International Compliance Information	19
FCC Compliance Information	20
Industry Canada Compliance Statement	20
CE Compliance Information	20
Electrical Safety	21
Waste Electrical and Electronic Equipment (WEEE) Directive Compliance	21
VCCI Class B ITE Compliance Information	21
MIC Certification Information	22
BSMI Certification Information	22

Chapter 1

Installation

For support, you will need to record the serial number and the part number for the card before installation.

Installation Overview

The installation of the card has slightly different procedures depending on whether you are replacing an existing card or installing a graphics card in a PC for the first time. This section briefly describes the high-level steps for both cases.

Replacing an Existing Card

If you are replacing an existing graphics card, you need to:

1. Start the computer and then uninstall the old graphics driver.
2. Turn off the computer and then remove the old card.
3. Install the new card and then connect the monitor.
4. Start the computer and then install the new drivers and software.
5. Restart the computer.

First Card for this PC

If this is the first graphics card for this PC, you need to:

1. With the computer off, install the new card and then connect the monitor.
2. Start the computer and then install the new drivers and software.
3. Restart the computer.

Record the Serial and Part Numbers

Write down the serial number and part number before installing. The serial number and 102 part number on the graphics card are required for registration and free support. They are located on a sticker on the back of the card.

Figure 1–1 Sample Serial and Part Numbers

The emphasized numbers in bold are required for registration and free support.

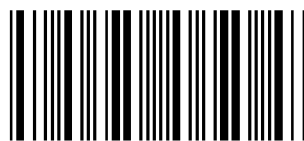

S/N (01)0072741548020 (21) 000000 000000



P/N 1028360100 057805 MADE IN CHINA

Uninstalling the Old Driver (Windows® XP)

Follow these steps to uninstall the existing graphics card driver in preparation for installation of a new card.

1. With the current graphics card still in the computer, close all open applications.
2. On the Windows taskbar, click **Start** ► **Control Panel** and then double-click **Add or Remove Programs**.
3. Select the current graphics card driver and then click **Add/Remove**.
The wizard will appear and help remove the current display drivers.
4. Turn off the system after the driver has been removed.

Note: If the previously installed graphics card has any additional software installed, this software may also need to be removed before restarting the computer. For example, DVD Player or Multimedia applications.

Uninstalling the Old Driver (Windows Vista™)

Follow these steps to uninstall the existing graphics card driver in preparation for installation of a new card.

1. With the current graphics card still in the computer, close all open applications.
2. Click **Start** ► **Control Panel**. Double-click **Programs and Features** and then select the graphics card driver from the list of software programs.
3. Double-click **Hardware and Sound** and then double-click **Device Manager**.
4. Expand **Display Adapter** and then right-click the driver for the graphics card you are replacing.
5. In the shortcut menu that appears, click **Install**.
The driver for the old graphics card is uninstalled.
6. Turn off the system.

Installing the Graphics Card

Note: Make sure that your system has an adequate power supply.

1. Make sure the computer, monitor, and other peripheral devices are off.
2. Unplug the computer power cord and disconnect the monitor cable from the back panel of the computer.

Caution:

To avoid possible damage to the motherboard, wait approximately 20 seconds after unplugging the power cord before disconnecting a peripheral or removing a component from the motherboard.

3. Remove the computer cover.

Caution:

Remember to discharge your body's static electricity by touching the power supply case or the metal surface of the computer chassis.

Tip: If necessary, consult the computer manual for help removing the cover.

4. Remove any existing graphics cards from the computer.

Warning:

Some graphics cards can get hot while operating. Wait approximately five minutes after turning off the computer before touching the card.

5. Locate the appropriate bus slot on the motherboard. If necessary, remove the corresponding back panel cover.
6. Align the new graphics card in the bus slot and press firmly until the card is fully seated.

Figure 1–2 Graphics Card Installation

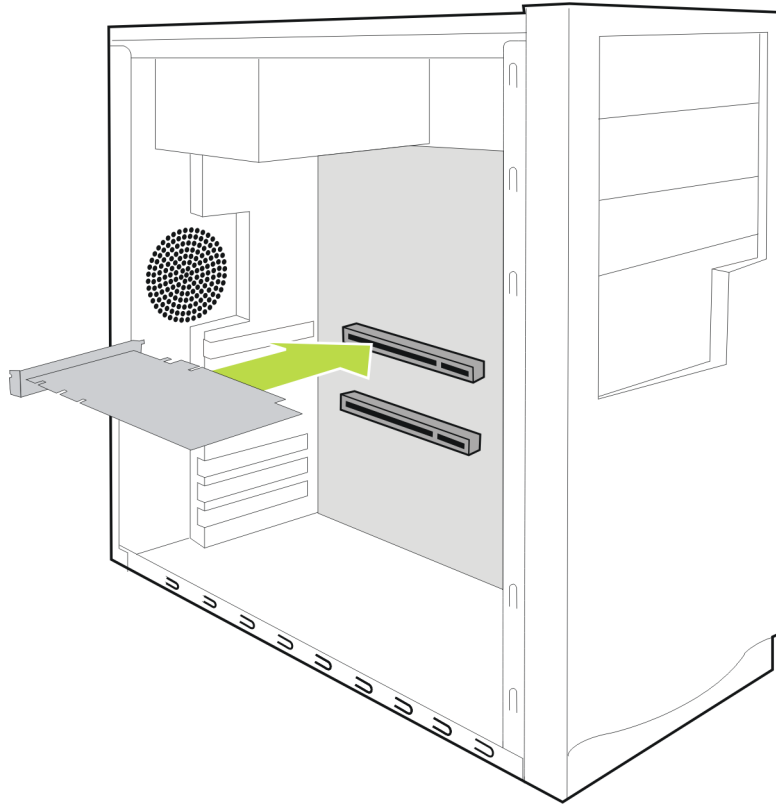

7. Fasten the graphics card securely to the back panel.
8. Make sure the cables are not interfering with anything inside the computer (for example, a cooling fan) and then replace the computer cover.
9. Reconnect any cables you have disconnected and plug in the computer power cord.
10. Turn on the monitor and then the computer.

The computer should start normally and the software must be installed next.

Installing the ATI Catalyst™ Software Suite

To install or remove software, you must have administrator rights or be logged on as a user with administrator rights.

Note: The installation dialog displays in English if the operating system's language is not supported.

Software is provided to both operate and take advantage of all the features of the graphics card. Software includes:

- The graphics card drivers.
- ATI Catalyst™ Control Center software.
- HydraVision™ software (included in the custom install).
- SurroundView™ software (included in the custom install).

- ATI Avivo™ video converter software (included in the custom install).
1. Insert the Software and Documentation CD.
 - Note:** If the install wizard does not start, navigate to the CD drive and double-click ATISSETUP.exe.
 2. From the menu that appears, click **Software Install**.
 3. Follow the on-screen instructions. When prompted, select either **Express** or **Custom**.
 - Not all software components are installed using the Express installation. Custom installation allows you to select individual software components for installation.*

Tip: If the installer fails to install the driver, or you have a software conflict, you can download the latest software from ati.amd.com/support/driver.html and then install it.

Display Configuration

This section describes how to configure the display and lists the available display connections.

Configure the Display (Optional)

If you are not experiencing any troubles with the display, no adjustments are necessary.

1. Right-click on the desktop and, in the shortcut that appears, click **Properties**.
 - The Display Properties dialog appears.*
2. Click the **Settings** tab and then select the screen resolution and color depth that best suit your requirements and the display's performance.
3. Click **Advanced** and then select the **Monitor** tab.
4. Choose a refresh rate from the drop-down list.

Caution:

Choosing a refresh rate unsupported by the display may damage it. Consult the display's documentation if necessary.

5. Click **OK**.
 - Once you have configured the main display you can configure any other displays that are connected.*
6. To configure another display, do the following:
 - a. Right-click on the desktop and, in the shortcut that appears, click **Properties**.

Note: The ATI Catalyst Control Center software can also enable and configure multiple monitors.



- b. To access the basic multi-monitor configuration settings, click the **Settings** tab.
- c. Select the monitor icon identified by the number 2.

Note: When using multiple monitors with the graphics card, one monitor will always be the primary display, additional monitors will be designated as secondary.
- d. Click **Extend my Windows desktop onto this monitor**.
- e. Set the Screen Resolution and Color Quality as appropriate for the second monitor.
- f. Click **OK**.

ATI Radeon HD 3400 series Connections

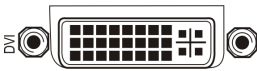
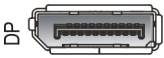

The following figure illustrates the typical connections on the ATI Radeon HD 3400 series graphics card. Available connections may vary between models.

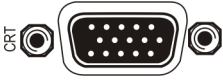
Table 1–1 Supported Connectors

Connector	Description
	The DVI-I Dual Link connection provides audio and video digital signals and HDMI™ output that is compatible with most HDMI devices.
	The DisplayPort™ connection provides audio and video digital signals.
	The HDMI connection provides audio and video digital signals.
	TV out
	VGA is an analog connector supporting video resolution mode of 640 × 480 pixels, the lowest standard resolution supported by most video cards.

Display Adapters (Optional Accessories)

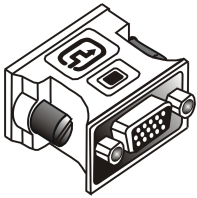
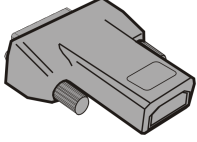
The following illustrates the adapters you can use to connect the graphics card to other display devices not directly supported by the connection types available on the graphics card.

Adapter	Description
	DVI-to-VGA adapter
	DVI-to-HDMI The HDMI adapter is a proprietary adapter manufactured and sold by approved manufacturers (like Wison Technologies Co., Ltd.) that has a specific detection mechanism to allow properly configured graphics cards to pass HDMI signals through a DVI connection to an HDMI compliant device.
	7-pin HDTV output cable
	DisplayPort-to-DVI adapter

Supported Display Connections

To ensure the highest possible performance, only one display device is supported when ATI CrossFireX™ is active. When ATI CrossFireX is active, display devices connected to the other connections on both graphics cards are rendered inactive.

The graphics card provides hardware support for DVI-I and VGA monitors, and HDMI HDTVs (either directly or using a DVI-to-HDMI adapter). It also provides TV output.

Table 1–2 Display Configurations (ATI CrossFireX Inactive)

Display	Connections
CRT analog display	<ul style="list-style-type: none"> • VGA connection • DVI-I-to-VGA adapter
LCD digital monitor	<ul style="list-style-type: none"> • DVI-I connection • VGA connection • DVI-I-to-VGA adapter • DisplayPort connection • DisplayPort-to-DVI adapter
TV	<ul style="list-style-type: none"> • DVI-to-HDTV adapter and RCA cables • 7-pin S-Video output cable • 7-pin S-Video-to-composite adapter and RCA cables
HDTV display	<ul style="list-style-type: none"> • DVI connection • DVI-to-HDTV adapter and RCA cables • DisplayPort-to-DVI adapter
HDMI HDTV	<ul style="list-style-type: none"> • HDMI connection • DVI-to-HDMI adapter and HDMI cable

ATI CrossFireX Introduction

ATI CrossFireX technology harnesses two or more GPUs (graphics processing units) to be used in a single computer to run a display, creating a high-performance gaming platform. Typically, setup involves 2 or more graphics cards, but with the appropriate motherboard, the technology can use a single card and the built-in GPU of the motherboard. ATI CrossFireX works with all 3D games and applications.

ATI CrossFireX is designed for optimal use on a single display; however, it is also possible for each GPU in an ATI CrossFireX configuration to individually drive their own monitors when ATI CrossFireX support is not enabled.

Note: The ATI Catalyst Control Center software contains a different ATI CrossFireX user interface for each configuration type and automatically loads the appropriate one when a valid ATI CrossFireX configuration is detected in your system.

If ATI Catalyst™ A.I. is enabled in the ATI Catalyst Control Center software, the optimal rendering mode available for the application is automatically selected.

Installing a Graphics Cards for Hybrid ATI CrossFireX Setup

Note: Make sure that your system has an adequate power supply.

An AMD-certified motherboard is required for a Hybrid ATI CrossFireX setup. For an up-to-date listing of certified motherboards, see ati.amd.com/products/certified.

Installing a graphics card for Hybrid ATI CrossFireX setup is the same as installing a graphics card normally. The difference is ATI CrossFireX can be enabled after installation.

1. Make sure the computer, monitor, and other peripheral devices are off.
2. Unplug the computer power cord and disconnect the monitor cable from the back panel of the computer.

Caution:

To avoid possible damage to the motherboard, wait approximately 20 seconds after unplugging the power cord before disconnecting a peripheral or removing a component from the motherboard.

3. Remove the computer cover.

If necessary, consult the computer manual for help removing the cover.

Caution:

Remember to discharge your body's static electricity by touching the power supply case or the metal surface of the computer chassis.

4. Remove any unneeded graphics cards from the computer.

Warning:

Some graphics cards can get hot while operating. Wait approximately five minutes after turning off the computer before touching the card.

5. Locate the PCIe® slots on the motherboard. If necessary, remove the corresponding back panel cover.
6. Align the new graphics card in the PCIe slot and press firmly until the card is fully seated.

Figure 2-1 Graphics Card Installation

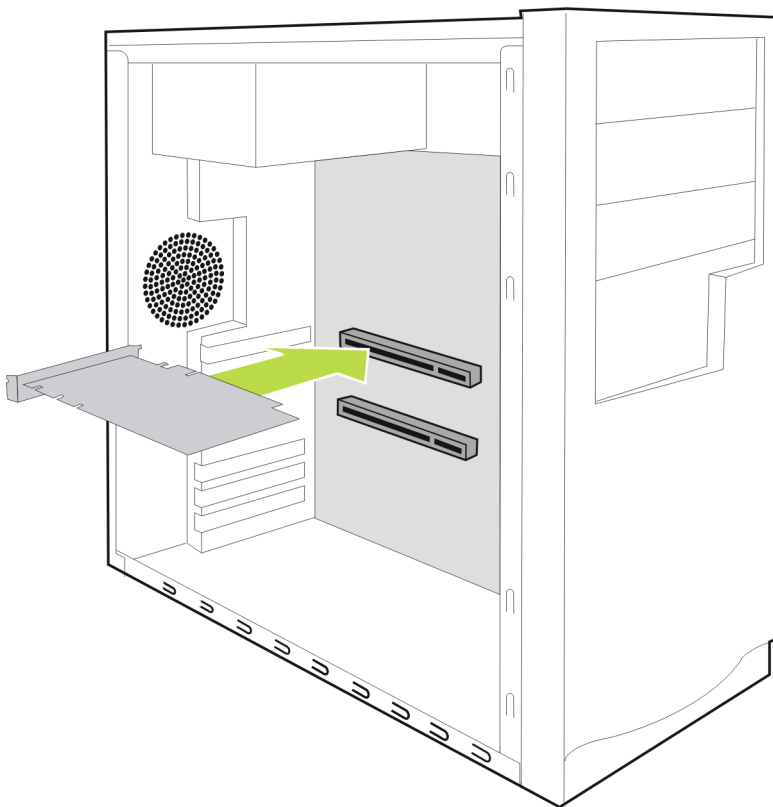

7. Fasten the graphics card securely to the back panel.
8. Make sure the cables are not interfering with anything inside the computer (for example, a cooling fan) and then replace the computer cover.
9. Reconnect any cables you have disconnected and plug in the computer power cord.
10. Turn on the monitor and then the computer.

You now need to enable ATI CrossFireX in ATI Catalyst Control Center.

Installing the Second Card for ATI CrossFireX Setup

This procedure describes installing a second card to complete a dual-card ATI CrossFireX setup and assumes the first card has already been installed.

Note: Make sure that your system has an adequate power supply.

1. Make sure the computer, monitor, and other peripheral devices are off.
2. Unplug the computer power cord and disconnect the monitor cable from the back panel of the computer.

Caution:

To avoid possible damage to the motherboard, wait approximately 20 seconds after unplugging the power cord before disconnecting a peripheral or removing a component from the motherboard.

3. Remove the computer cover.

If necessary, consult the computer manual for help removing the cover.

Caution:

Remember to discharge your body's static electricity by touching the power supply case or the metal surface of the computer chassis.

4. Remove any unneeded graphics cards from the computer.

Warning:

Some graphics cards can get hot while operating. Wait approximately five minutes after turning off the computer before touching the card.

5. Locate the PCIe slots on the motherboard. If necessary, remove the corresponding back panel cover.
6. Align the new graphics card in the secondary PCIe slot next to the existing graphics card and press firmly until the card is fully seated.
7. Remove protection tags from the ends of the ATI CrossFireX interconnects and connect the cards.

Caution:

Always handle the interconnects by the connector only. Do not push or pull on the flexible cable.

Figure 2-2 ATI CrossFireX Bridge Interconnect Protection Tag

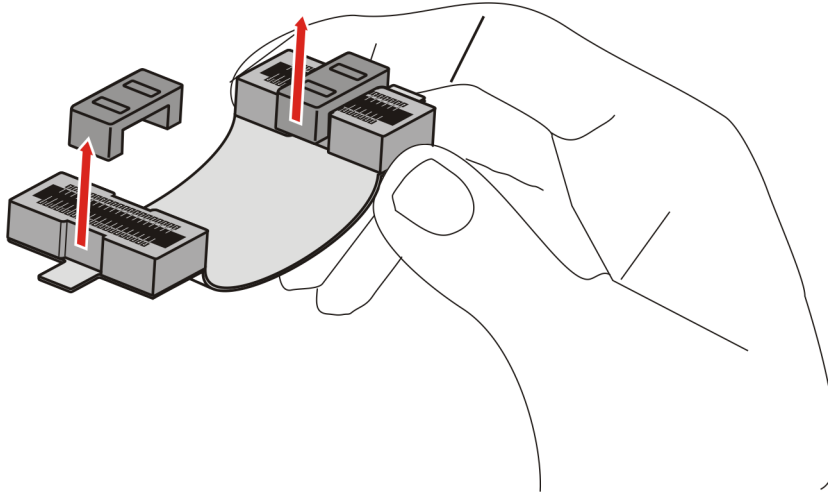
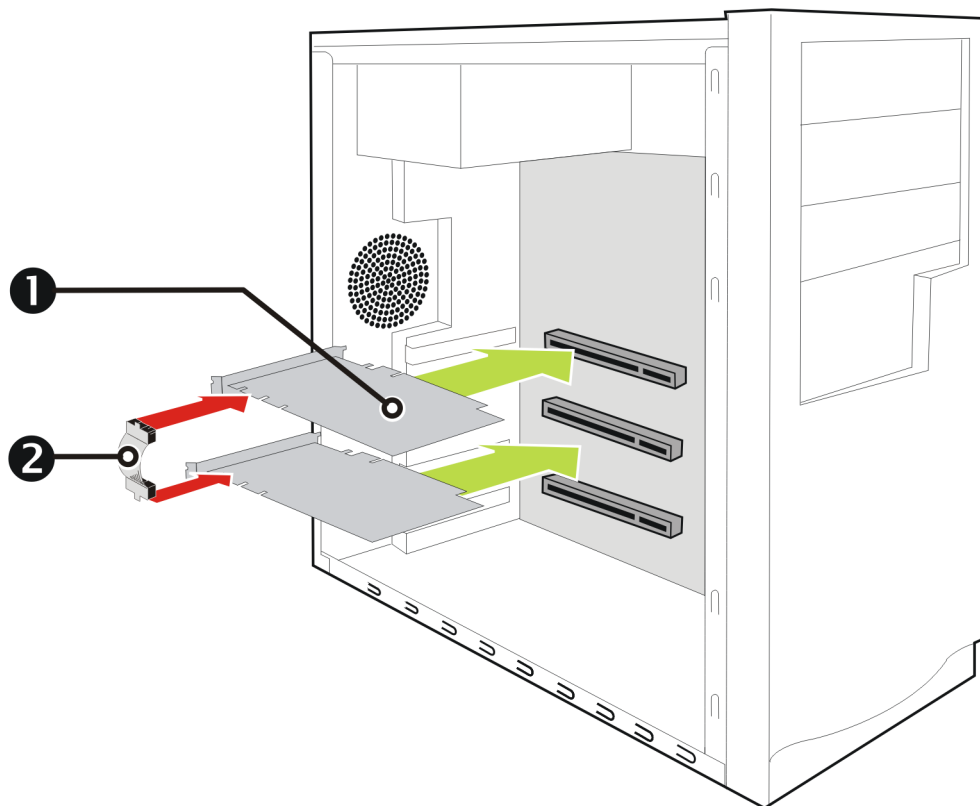

Figure 2-3 ATI CrossFireX Installation



1	ATI CrossFireX graphics card
2	Interconnect

8. Fasten the graphics cards securely to the back panel.
9. Make sure the cables are not interfering with anything inside the computer (for example, a cooling fan) and then replace the computer cover.

10. Reconnect any cables you have disconnected and plug in the computer power cord.
11. Turn on the monitor and then the computer.

You now need to enable ATI CrossFireX in ATI Catalyst Control Center.

Enabling ATI CrossFireX

When a ATI CrossFireX configuration is detected for the first time by the ATI Catalyst display driver, ATI CrossFireX is automatically enabled, and the best possible GPU combination is selected based on your hardware configuration. If necessary, you can change the existing ATI CrossFireX configuration using the following procedure.

1. From the Graphics Settings tree in the ATI Catalyst Control Center software, click **CrossFire™**.
2. From the **Graphics Adapter** list, select the graphics card that acts as the Display GPU.
3. Select **Enable CrossFire™**.

Note: If your system has more than two ATI CrossFireX graphics cards, the Selecting a Render GPU dialog appears prompting you to select a graphics card to partner with the Display GPU.

4. Click **Apply**.

When ATI CrossFireX is enabled, GPU Accelerated Physics is automatically disabled for all cards in the configuration as are all displays except the one used by ATI CrossFireX.

ATI CrossFireX Troubleshooting

Change Motherboard BIOS Settings

Some motherboards may have a system BIOS option to switch between single and dual PCIe slot support. The default setting may be single slot support. Refer to the motherboard's manual for information to enable dual PCIe slot support.

For more information see the ATI CrossFireX Web page at ati.amd.com/crossfire.

Use Graphics Cards with Different Amounts of Memory

In some ATI CrossFireX configurations, graphics cards with different amounts of memory can be used; however, restarting your computer is required after enabling ATI CrossFireX. This will cause ATI CrossFireX to reduce the amount of memory on the card with the most amount of memory to match the memory size of the graphics card with the least amount of memory.

Clicking **OK** to the memory mismatch error message will restart your computer.

Note: When disabling ATI CrossFireX you will be given the option to restart your computer to restore the original graphics memory size or continue with the reduced memory size.

3D Client is Active

You will not be able to start ATI CrossFireX if a 3D application, game, or video playback, such as a DVD movie, is running.

Close all open 3D applications, games, and movie player applications, and then enable ATI CrossFireX.

ATI CrossFireX is Currently Unavailable

This error has occurred because ATI CrossFireX did not correctly detect your graphics hardware or there is a problem with the software.

- Check that the graphics cards are installed correctly.
- Check that the interconnect cable is installed correctly.
- Close all running 3D applications.
- Re-install the ATI Catalyst Control Center and drivers.

Screen Rotation is Unavailable

Screen rotation function does not work or is unavailable.

Screen rotation is not an available feature on ATI CrossFireX systems.

Video Displays Flicker During System Startup

This is normal during ATI CrossFireX start-up.

ATI CrossFireX Starts in Software Mode

This is normal when starting up for the first time after installing two ATI CrossFireX graphics cards if neither card is installed in the primary PCI Express® slot. You can change the ATI CrossFireX mode in the ATI Catalyst Control Center.

ATI CrossFireX Disabled After Swapping/Moving Cards

If you change the ATI CrossFireX configuration by moving the graphics cards to different slots on the motherboard, disable ATI CrossFireX and restore factory default settings in ATI Catalyst Control Center first. Once the cards have been swapped, enable ATI CrossFireX. This ensures the new configuration is detected by the computer.

The following section offers troubleshooting tips and provides customer care, warranty, and compliance information.

System Requirements

Hardware

Minimum requirements are:

- Motherboard with one PCIe ×16 lane graphics slot.
- AMD Athlon™ or Intel® Pentium® 4 CPU.
- 1 GB RAM.
- CD-ROM or DVD-ROM drive for installing software.
- A 400 watt or better power supply. For a list of certified power supplies, see ati.amd.com/certifiedpsu.

CrossFire Requirements

To implement a CrossFire configuration using the ATI Radeon HD 3400 series requires:

- A CrossFire certified motherboard. For an up-to-date listing of certified motherboards, see ati.amd.com/products/certified.
- A PCIe 400 watt or greater power supply. For an up-to-date listing of certified power supplies, see ati.amd.com/certifiedpsu.

Using ATI Catalyst Control Center

ATI Catalyst Control Center Overview

The ATI Catalyst Control Center software provides access to the display features of the graphics card. Use the software to fine-tune graphics settings, enable or disable connected display devices, and change the orientation of the desktop. Many features display previews of the changes before they are applied.

Basic View	A simplified view of the features that includes wizards to quickly make changes.
Advanced View	A powerful interface that enables complete configuration of the feature set of the graphics card.

The ATI Catalyst Control Center software can be customized for easy access to the most-used features.

For information on the individual features of the software, access the comprehensive in-program help system (see [Accessing Help](#) or visit the AMD Customer Care Web site at <http://ati.amd.com/support/>).

Starting the ATI Catalyst Control Center Software

The following table shows the ways you can start the ATI Catalyst Control Center software:

Table 3-1 ATI Catalyst Control Center Access Routes

Access Route	Instructions
Windows Desktop	<ol style="list-style-type: none"> 1. Right-click anywhere on the desktop. 2. From the shortcut menu that appears, click ATI CATALYST(R) Control Center.
Windows Start Menu	<ol style="list-style-type: none"> 1. Click Start on the Windows task bar. 2. Select All Programs ► Catalyst Control Center.
Windows System Tray	<ol style="list-style-type: none"> 1. Right-click the ATI icon in the Windows System Tray. 2. From the short menu, select ATI Catalyst Control Center.
Desktop Shortcut	When you first installed the ATI Catalyst Control Center, the setup wizard provided you with the option of placing a shortcut on the desktop. If you chose this option, you can double-click the ATI Catalyst Control Center desktop shortcut.
Predefined Hot Keys	Press the predefined hot keys, Ctrl+Alt+C , to launch ATI Catalyst Control Center. You can also define your own hot key sequence by using the ATI Catalyst Control Center Hotkey Manager.

Accessing ATI Catalyst Control Center Help

ATI Catalyst Control Center Help provides information on the features and concepts of your ATI Radeon graphics card. You can also use the ATI Catalyst Control Center Help feature to access usage information, generate a problem report, and get software version information for your graphics card.

1. Open ATI Catalyst Control Center in the **Advanced view**.
2. Choose one of the following options:
 - Press the **F1** key at any time to get specific help on the currently displayed information.
 - From the ATI Catalyst Control Center Dashboard, choose **Help** ► **Help Contents** to browse the entire help contents.
 - From the ATI Catalyst Control Center Dashboard, choose **Help** ► **Search Help** to search the help contents for a specific term.
 - To access AMD's Web site, from the ATI Catalyst Control Center Dashboard, choose **Help** ► **Go to ATI.com**.

Searching the Help

1. In Advanced view, click **Help** in the Dashboard.
2. Click **Search Help**.
3. Enter the word(s) you wish to search for the in search box of the ATI Catalyst Control Center Help.
4. Click **Go**.

Graphics Card Installation Troubleshooting Tips

For more advanced troubleshooting information, contact AMD Customer Care for ATI products at ati.amd.com.

The graphics card doesn't fit any of the motherboard slots.

The graphics card needs to be exchanged for one with a bus that matches the motherboard.

The computer beeps and the boot process stops.

Make certain that the graphics card is properly connected to the internal power supply and the motherboard.

The computer does not boot up properly.

Verify that the installation instructions were followed correctly.

Make certain that the graphics card is properly connected to the power supply and the motherboard.

If using Windows operating system, restart your computer in Safe Mode. For information on Safe Mode, consult the Windows documentation.

Check the system configuration utility for interrupt assignments.

The computer boots up but there is no display.

Verify that the monitor is connected properly to the computer and a power supply.

If your motherboard has on-board graphics capabilities, you may need to disable them. Consult your motherboard documentation for more information.

Note: Some manufacturers do not allow the on-board graphics to be disabled or to become the secondary display.

HDTV/HDTV Adapter Troubleshooting

For more advanced troubleshooting information, contact AMD Customer Care for ATI products at ati.amd.com.

Table 3–2 HDTV/HDTV Adapter Troubleshooting Tips

Problem	Possible Solution
The colors on the TV display are incorrect.	Ensure that the connections between the component video adapter and the HDTV are correct.
There is no display on the TV.	The TV will not display anything until Windows starts; this may take several minutes. Make sure the TV is set to YPbPr input. Make sure that the HDTV component video adapter is properly connected.
DVDs will not play in high-quality modes.	Copy-protected DVDs restrict playback to 480i and 480p modes.
The entire display is not visible.	If the component input device supports it, try 720p mode.
The display appears tilted.	Consult the HDTV documentation.
The CRT display is green.	The system is in component output mode. Restart the computer with only the CRT monitor connected.

Customer Care

For detailed instructions on how to use your product, refer to the documentation included on the installation CD.

To activate Customer Care, you must register your product at ati.amd.com/online/registration.

If you require further assistance with your product, the following Customer Care options are available:

Service	Availability	Language	Access
Online or mail	24 hours a day	English, French, Spanish	http://ati.amd.com/support/ or Advanced Micro Devices, Inc., Graphics Product Group, Attention: Customer Care, 1 Commerce Valley Drive East, Markham, Ontario, Canada L3T 7X6
Telephone US & Canada	Monday to Thursday: 9:00 a.m. to 5:30 p.m. Friday: 9:00 a.m. to 3:00 p.m. Note: AMD reserves the right to change hours of support. For more information, please refer to ati.amd.com/support/terms/ .	English	1-877-284-1566 (toll-free) or 1-905-882-2626 (Canada) (International and/or local toll charges to Canada will apply).

AMD Customer Care for Graphics Products will work to resolve your issue and help you to get your ATI product up and running. If your issue is not resolved, our technicians will determine whether the difficulty you are experiencing is the result of the ATI product, whether your product contains a defect, and whether your product is under warranty.

- AMD Customer Care is unable to assist with refunds, returns, or exchange-specific inquiries. If resolving the problem being experienced is critical to your decision to keep the product, it is your responsibility to ensure that you know and are within the period of time your reseller will allow for refunds, returns, or exchange.
- AMD is not responsible for any expense incurred accessing Customer Care. It is expected that customers will review the expense associated with the available support options and will choose the method that best meets their needs and budget.
- AMD Customer Care reserves the right to limit support options for products that are not registered or are reaching end of life.

International Compliance Information

This section details the worldwide compliance information for this product, which is manufactured to be compliant in the regions where it is sold.

FCC Compliance Information

This product complies with FCC Rules part 15. Operation is subject to the following conditions:

- This device may not cause harmful interference.
- This device must accept any interference received, including interference that may cause undesired operation.

This equipment has been tested and found to comply with the limits for a Class B digital device, pursuant to Part 15 of the FCC Rules. These limits are designed to provide reasonable protection against harmful interference in a residential installation. This equipment generates, uses and can radiate radio frequency energy and, if not installed and used in accordance with manufacturer's instructions, may cause harmful interference to radio communications. However, there is no guarantee that interference will not occur in a particular installation. If this equipment does cause harmful interference to radio or television reception, which can be determined by turning the equipment off and on, the user is encouraged to try to correct the interference by one or more of the following measures:

- Re-orient or relocate the receiving antenna.
- Increase the separation between the equipment and receiver.
- Connect the equipment to an outlet on a circuit different from that to which the receiver is connected.
- Consult the dealer or an experienced radio/TV technician for help.

The use of shielded cables for connection of the monitor to the graphics card is required to ensure compliance with FCC regulations. Changes or modifications to this unit not expressly approved by the party responsible for compliance could void the user's authority to operate this equipment.

Complies with FCC 15.107, 15.109, 15.111, and 15.117.

For further compliance information:

Advanced Micro Devices, Inc.
62 Forest Street
Marlborough, MA 01752
USA Tel: 508-303-3900

Industry Canada Compliance Statement

This Class B digital apparatus complies with Canadian ICES-003 and with BETS-7, Section 3.6.

Cet appareil numérique de la Classe B est conforme à la norme NMB-003 du Canada, et NTMR-7, Section 3.6.

CE Compliance Information

EMC Directive 2004/108/EC CISPR 22:2003 +A1:2004/EN 55022:1998 +A1:2000 +A2:2003—Class B: Limits and methods of measurement of radio disturbance characteristics of Information Technology Equipment. CISPR24:1997/EN 55024:1998 +A1:2001 and +A2:2003—Information Technology Equipment—Immunity Characteristics—Limits and Methods of Measurements

Electrical Safety

Europe: The Low Voltage Directive—2006/95/EC EN 60950-1, 1st edition—Safety of Information Technology Equipment

USA/Canada:

- UL 60950-1, 1st edition, 2006-07-07 (Information Technology Equipment—Safety—Part 1: General Requirements)
- CSA C22.2 No. 60950-1-03, 1st edition, 2006-07 (Information Technology Equipment—Safety—Part 1: General Requirements)

To meet UL safety requirements, the computer's maximum room temperature should not exceed 40 °C.



Waste Electrical and Electronic Equipment (WEEE) Directive Compliance

This product was manufactured by Advanced Micro Devices, Inc.



VCCI Class B ITE Compliance Information

この装置は、情報処理装置等電波障害自主規制協議会（VCCI）の基準に基づくクラスB 情報技術装置です。この装置は、家庭環境で使用することを目的としていますが、この装置がラジオやテレビジョン受信機に近接して使用されると、受信障害を引き起こすことがあります。

取扱説明書に従って正しい取り扱いをして下さい。

MIC Certification Information

B급 기기 (가정용 정보통신기기)

이 기기는 가정용으로 전자파적합등록을 한 기기로서
주거지역에서는 물론 모든지역에서 사용할 수 있습니다.

"Class B" Equipment (Household purpose info/telecommunications equipment)
As this equipment has undergone EMC registration for household purpose, this
product can be used in any area including residential area.

BSMI Certification Information

CNS 13438 · C6357 · B類 — 資訊科技設備